

Article number: 03482012
 Description: Fluro Rod end EAL 12
 Note: 12

Measures

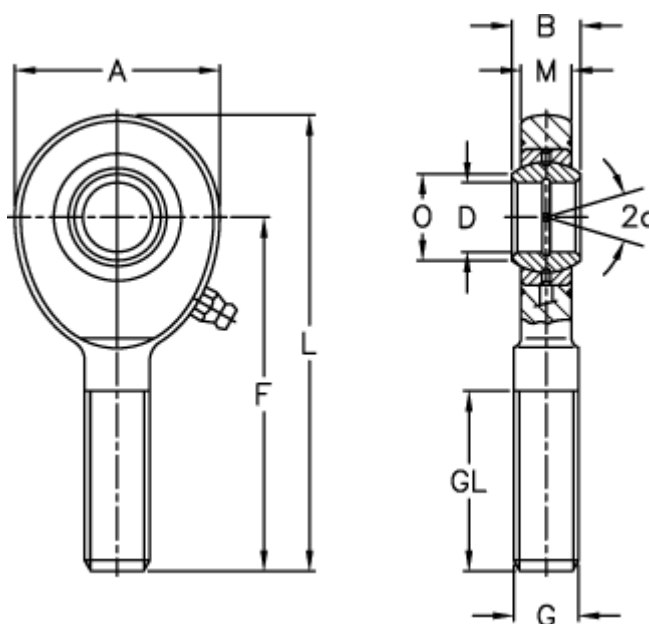

A	= 34	L	= 71
a (degrees)	= 11	M	= 8
B	= 10	O	= 14.9
D	= 12	Static drive kN	= 29
Dynamic drive (kN)	= 10.8	Weight	= 86
F	= 54		
g	= M12		
GL	= 28		